



Vista

SQ10 Series Network Square Speaker

ZYCOO Network Square Speaker SQ10 Vista is a comprehensive, high-performance SIP-enabled speaker. With the built-in HD camera and built-in microphone, the operators can detect the indoor environment and delivery two-way communication at any time, anywhere. It is perfect to use in scenarios like classrooms, libraries, offices. Plus, it provides both surface-mounted and flush-mounted enclosures to choose from regarding different application scenarios.

Applicable Scenarios



Schools



Health Care



Office Buildings



Hotel Lobbies



Airports



Pharmacies



Banks



Residential Buildings



Restaurants



Hospitals

Features



Microphone

Integrated microphone allows for half-duplex or full-duplex paging based on software platform used. When used with the push button, calls to a predetermined extension or trigger a task can be initiated from the room with the speaker.



Camera

Within the built-in HD camera, operator can detect the indoor environment at any time, anywhere using the Dispatch Console. Camera's RTSP address is also provided.



Audio

320Kbps superior quality MP3 music files and streamed media supported. Click to play music, immediate announcement, intercom, schedule music and paging are all supported.



PoE+

SQ10 is PoE supported, making it easy to connect into local area networks from your PoE switch with a CAT 5/6 cable. No extra power cables are needed.



SIP Integration

Standard SIP protocol implemented, you can register the SQ10 into any third-party SIP server such as IPPBX system or PA system.



Peripheral Integration

With the support of peripheral integration, the SQ10 can connect with strobes, call buttons, volume controllers, external LED/LCD monitors, door magnetism, etc.



Diverse Installation

Four additional knockout holes are implemented along each side of the enclosure, allow cables to plug into the speaker in any direction.

Specifications

Speaker	
Speaker Size	4.5 inch
Average Sensitivity	91dB/1m/1W
Frequency Response	70Hz~20KHz
THD	<0.1%
Max SPL at 1m (Passive)	101dB
Amplifier	Single Channel Class-D Topology
Rated Power	8Ω 10W
Coverage Pattern	90°H 50°V 30m ²
Audio	
Network Audio Types	G.722, G.711 A-law, G.711 U-law, Opus
Network	
Ethernet	IEEE 802.3 10/100Base-T
PoE	IEEE 802.3 AT Compliant
Supported Protocols	SIP(RFC3261), HTTP, TCP/IP, SSL, DNS, SNTP, NTP, RTSP, RTP, RTCP, TCP, UDP, MQTT, ICMP, DHCP,
IP Addressing	DHCP / Static
Mechanical Properties	
Memory	128MB RAM, 256MB Flash
AC Power Input	PoE+ and External 24VDC
Casing Material	Cold rolled steel finished in textured white epoxy
Mounting Method	Wall mounted
Color	White
Weight	3.15kg(6.95lb)
Dimensions – Surface-mounted	280*280*65mm
Dimensions – Flush-mounted	300*300*65mm
SYS Light Status	On/Off/Flash
PWR Light Status	On/Off/Flash
RST Key	Press and hold for 3 seconds to announce IP address; Press and hold for 10 seconds to reset device to factory defaults.
Environmental	
Installation Environment	Indoor
Operating Temperature	-20°C - 50°C (-4°F - 122°F)
Storage Temperature	-40°C - 70°C (-40°F - 158°F)
Humidity	10% - 95% RH Non-condensing
Approvals	
Approvals	EN 55032:2015, EN 55035:2017, EN 61000-3-2:2014, EN 61000-3-3:2013, EN 62368-1:2014+A11:2017, FCC Part 15B Class A
Warranty Coverage	
Warranty Period	2 Year Limited

Dimensioning

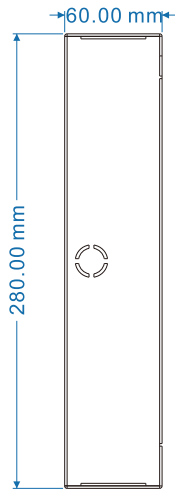

Side

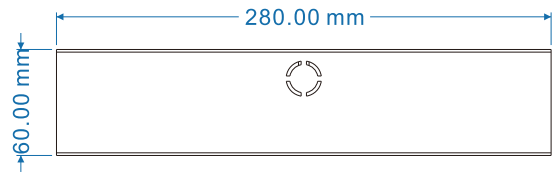

Top

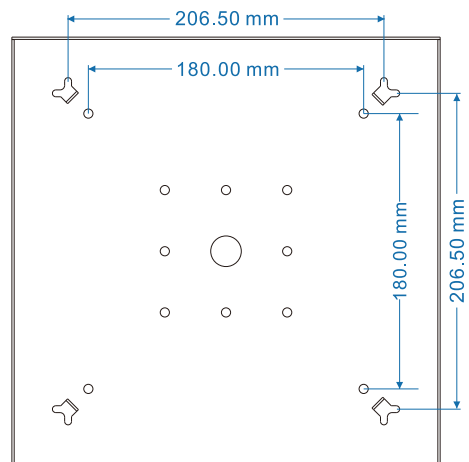

Rear-back

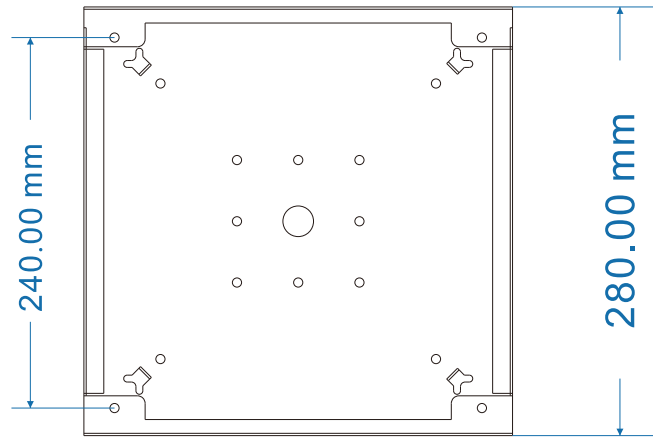

Rear-front

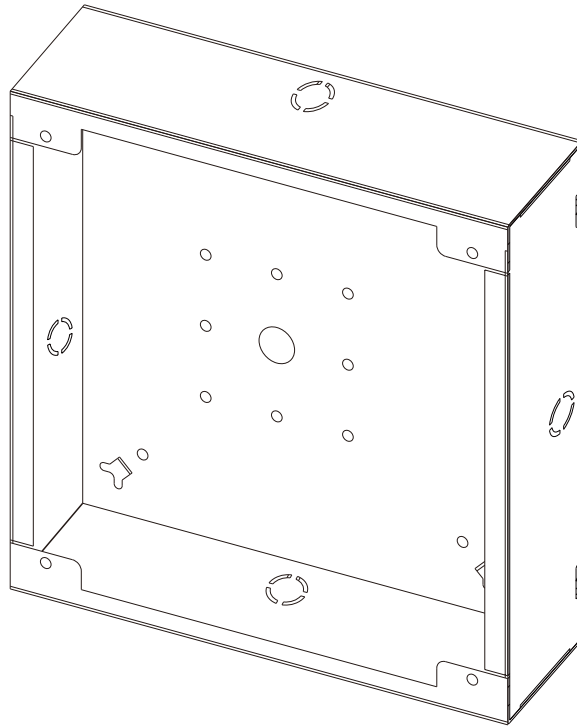

(Perspective)

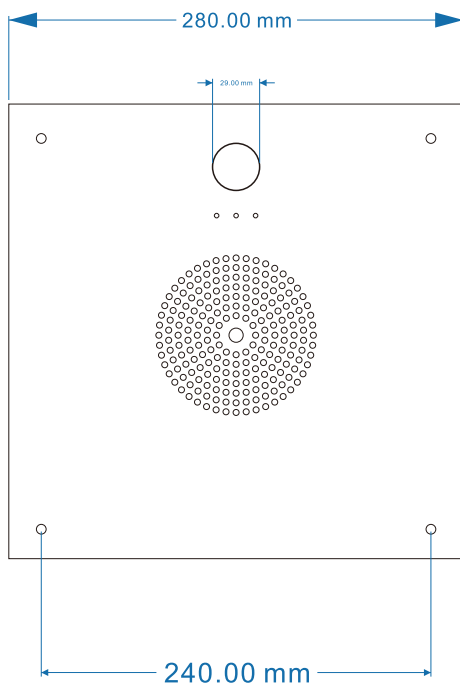

(SQ10-V)

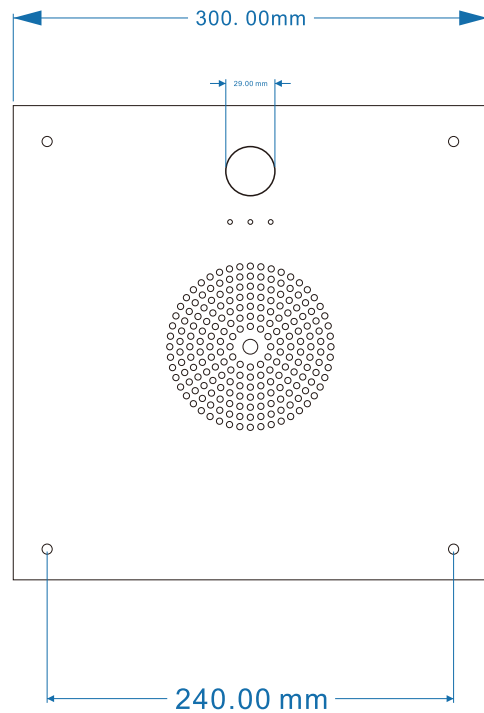

(SQ10-VF)



We Focus · We Deliver

16F, D5, Tianfu Software Park, Chengdu, China

+86 28 85337096

zycoo@zycoo.com