

DESCRIPTION

The CA-130 is a 1-DIN size unit 30 W car amplifier designed for use with a 12 V battery car.

SPECIFICATIONS

Power Source	Standard voltage: 14 V DC Usable voltage: 10 – 16 V DC (12 V battery used)
Power Consumption	5 A or less at rated output
Rated Output	30 W
Output Impedance	4 Ω (BRN), 8 Ω (ORG), Common (WHT) Changeable by changing lead wire connections
Distortion	Less than 5% (at 1,000 Hz rated output)
Frequency Response	100 – 10,000 Hz
Input	Mic1, 2: 600 Ω, 4 mV, phone jack Aux : 10 kΩ, 500 mV, phone jack
Finish	Front panel: ABS resin, black Case : Zinc plated steel sheet
Dimensions	178 (W) × 50 (H) × 144 (D) mm (Mounting device excluded)
Weight	1.1 kg
Accessory	Microphone holder 1, Mounting bracket 1, Mounting screw 1set, Fuse (8 A) 1, Connection cord 1set
Accessory Microphone	Unidirectional dynamic type with talk switch Impedance: 600 Ω Sensitivity : -53 dB (1 kHz, 0 dB = 1 V/Pa)

APPEARANCE

Rear View

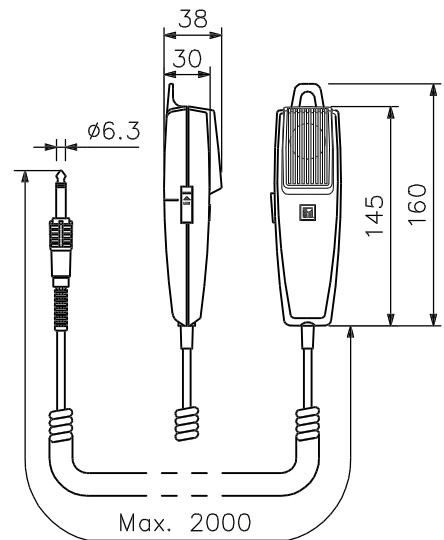
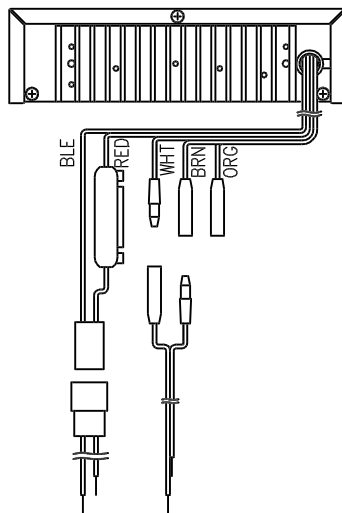

Accessory microphone (1/5)

Top View

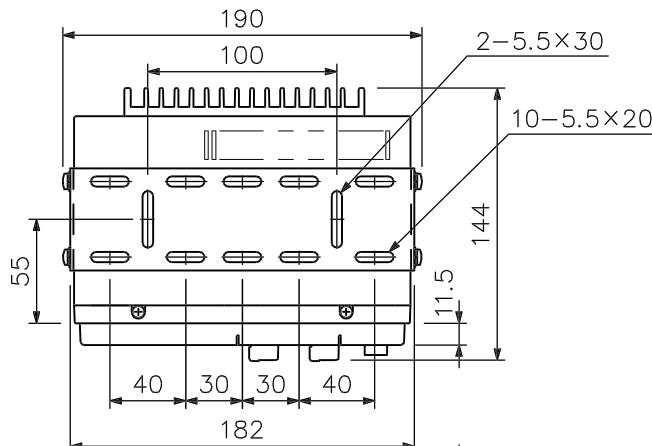

Front View

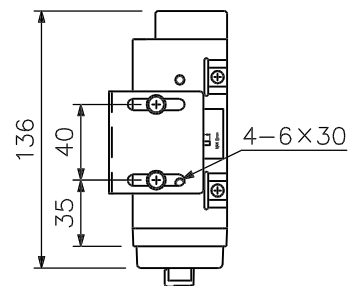
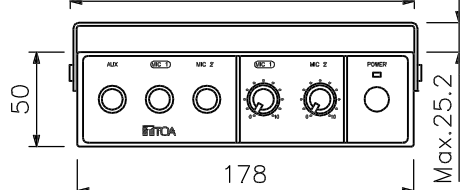

Side View

UNIT:mm SCALE:1/4